

**Exemple coulissant minimal à ouvrant caché**

**COUPES**

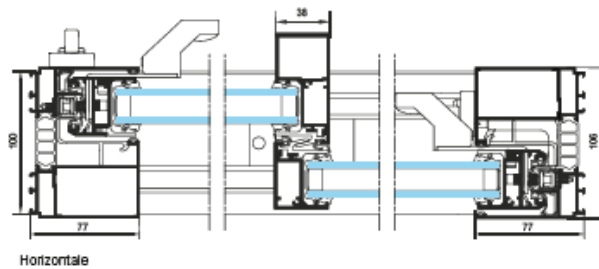

Horizontale

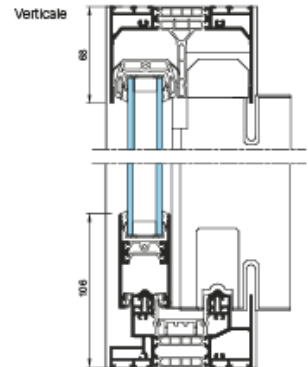

Verticale

**Coulissant standard**

**COUPES**

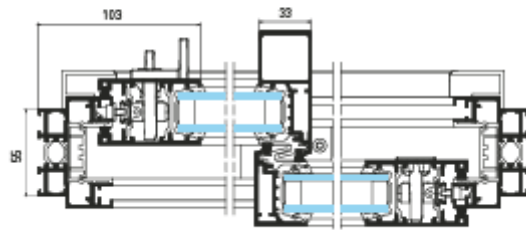

Horizontale

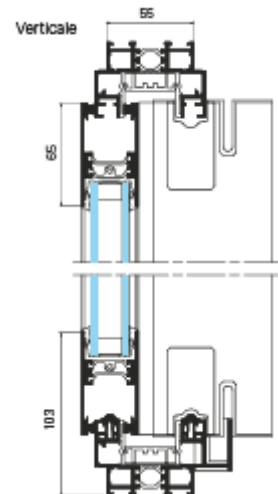

Verticale

**Coulissant d'angle**

**COUPES**

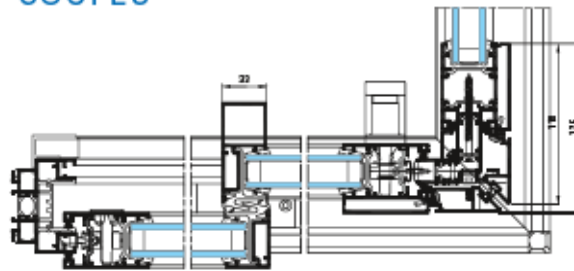
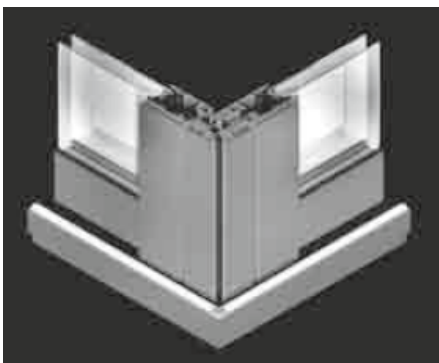

Angle sortant

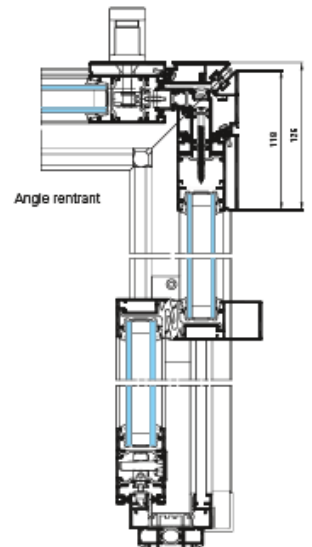

Angle rentrant

**Coulissant à levage :**

